

V860 299 INTERIOR LETTERFLAP

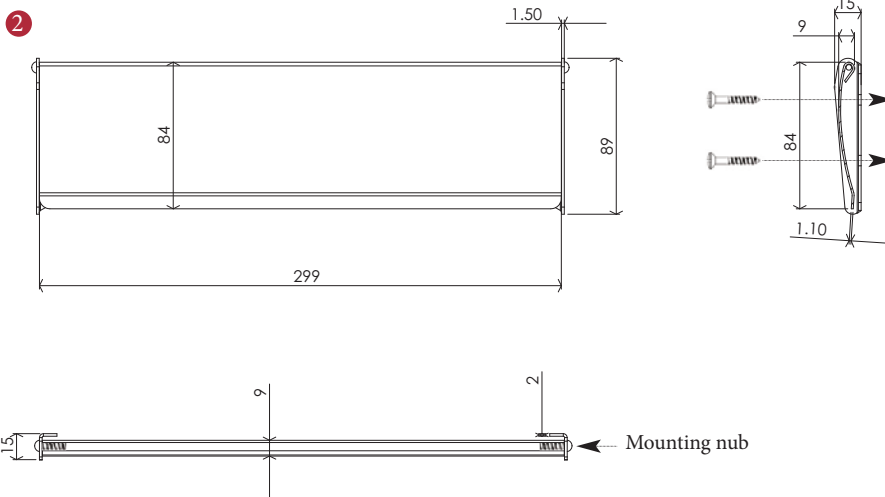

1

2

2 Dimensions: see the outlines given above

3  12.5mm

FITTING

- 1 Position Letterflap over aperture in door to determine the optimum position for fixing.
- 2 Having determined Letterflap position, mark out where screws will be affixed through the two [left-side/right-side] brackets (as illustrated above), and secure the first bracket in place, ensuring that the mounting nub is uppermost and facing inward (towards the aperture to be covered).
- 3 Slide the Letterflap onto the mounting nub of the now affixed bracket, and then slide the second bracket onto the other other end of the Letterflap, and now affix that bracket where you have previously marked to secure the Letterflap firmly in place. Test.

Overview

1 Interior Letterflap illustrated

2 General Dimensions of Interior Letterflap

3 Supplied with: 4x 12.5mm screw

M Marcus Ltd., Dudley

Product Code

V860 299

Material

Solid Brass

Available in all Heritage Brass finishes.

Sizes shown are in mm and approximate. We reserve the right to amend where necessary and without any prior notice.