

V4043 ROUND BATHROOM TURN & RELEASE

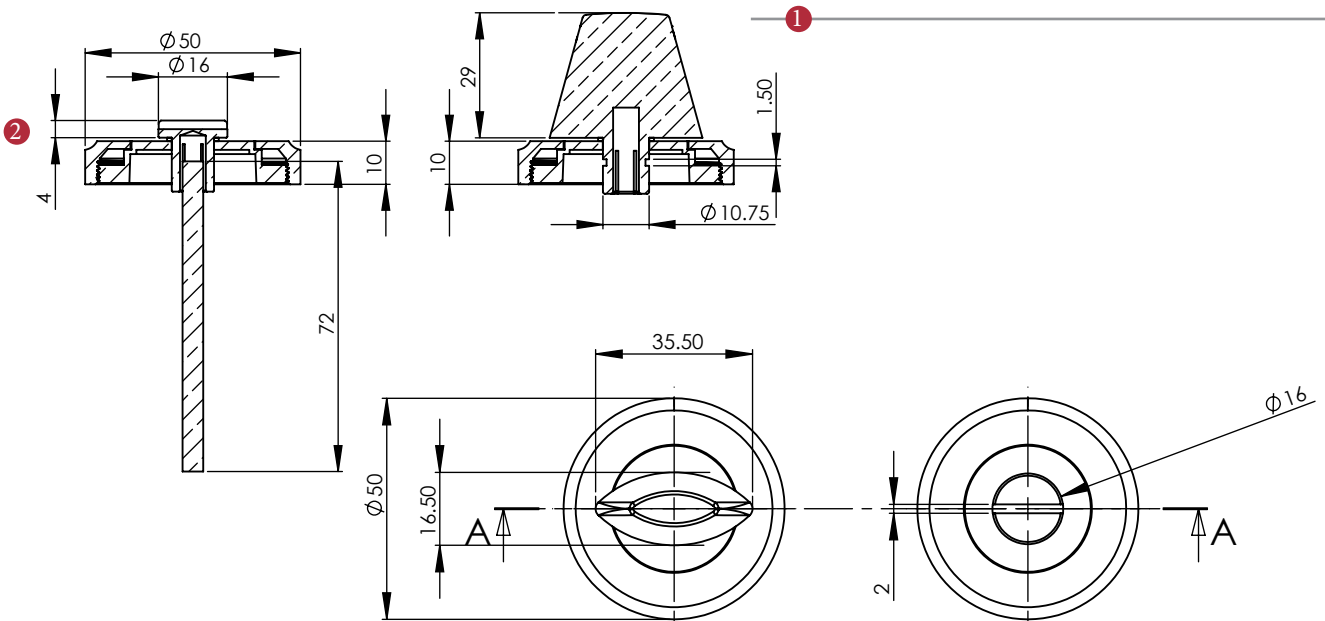











2 Dimensions: see the outlines given above

3  18mm



FINISHES

-  ME Matt Bronze
-  SB Satin Brass
-  SN Satin Nickel
-  AT Antique Brass
-  SC Satin Chrome
-  MC Mercury Finish (SN with PN edge)
-  CB Polished Chrome/Brass
-  PN Polished Nickel
-  PB Polished Brass
-  PC Polished Chrome

Overview

1 Turn & Release illustrated

2 General Dimensions of Turn & Release

3 Supplied with: 4x 18mm screws
1x Spindle 5mm x 77mm
1x Spindle 5mm x 65mm

M Marcus Ltd., Dudley

Product Code

V4043

Material

Solid Brass

Sizes shown are in mm and approximate. We reserve the right to amend where necessary and without any prior notice.