

CAM-TOWEL-60-MA : Towel Rail

Towel Bar Rail, Wall Mounted for Bathroom and Kitchen 60cm Matt Antique Finish

Material: Zinc Alloy | **Finish:** Antique Bronze



Product Dimensions (All dimensions are in millimeters unless otherwise indicated)

We reserve the right to amend where necessary and without any prior notice.

Base Diameter : 58 | Projection : 77 | Length : 600 | Tube Diameter : 15

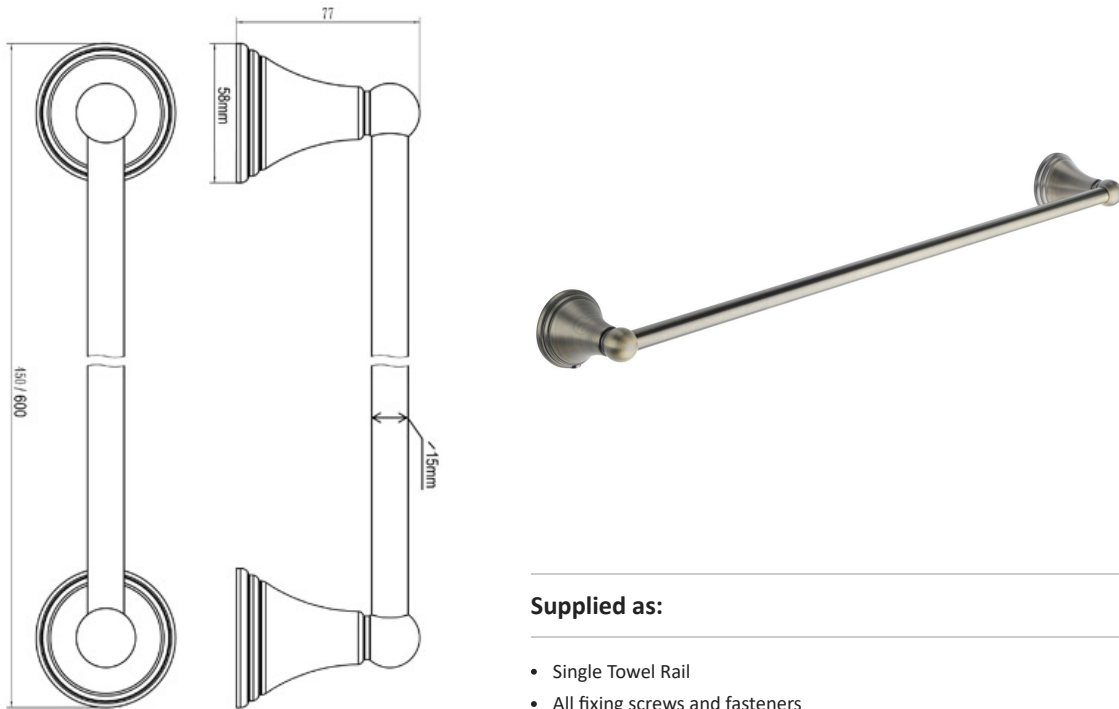

Supplied as:

- Single Towel Rail
- All fixing screws and fasteners

Available Finishes



Antique Bronze



Polished Chrome

Products in the Set



Towel Rail 45cms
CAM-TOWEL-45-MA



Toilet Roll Holder
CAM-PAPER-MA



Robe Hook
CAM-HOOK-D-MA



Towel Ring
CAM-RING-MA



Tumbler Holder
CAM-TUMBLER-MA



Soap Dispenser
CAM-SOAP-MA

+44 (0)1384 457 900

www.m-marcus.com

info@m-marcus.com

Installation Instructions

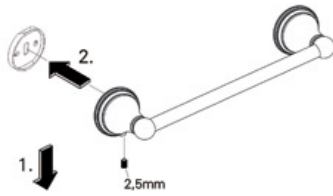

1. Loosen the set screw on the accessory and remove the backing plate. Position the accessory against the wall and mark outline with pencil.

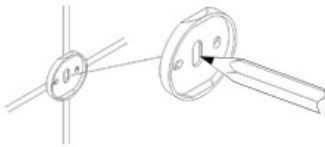

2. Position the backing plate flat side down on the wall and mark holes with pencil.

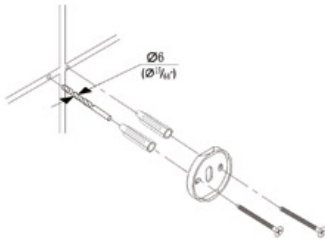

3. Mount to drywall
Predrill holes on the wall to fit wall anchors.
(15/64" Drill bit recommended).
Insert wall anchors into the wall.
Position backing plate flat side down over the anchors and install screws.
Mount to wood
If installing on wood surface, use wood screws. (No anchors required).

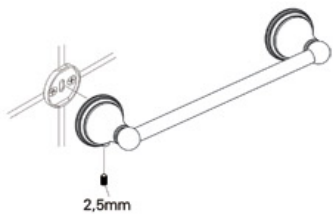

4. Slide the accessory onto the backing plate and tighten the set screw using Allen Key provided.

Repeat Steps 1 to 4 for the other backing plate