

C1560 8 3" NUMERAL SCREW FIXING

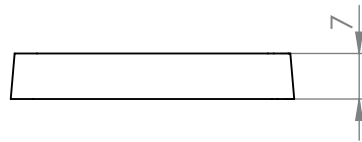
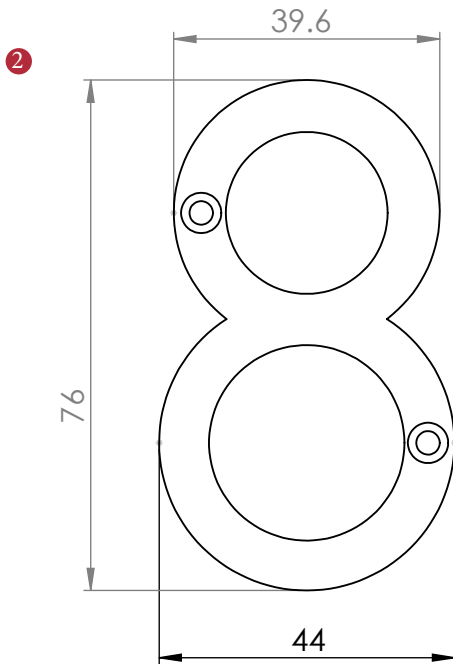

- ② Dimensions: see the outlines given above
- ③ Steel starter screw x 1pc.
Drill pilot holes, use the starter screw to cut a thread
- ④ 2x Brass wood Screw
Fasten the Brass Screw into the Pilot hole

FINISHES

- ME Matt Bronze finish
- SB Satin Brass finish
- PN Polished Nickel finish
- SN Satin Nickel finish
- AT Antique Brass finish
- SC Satin Chrome finish
- PE Polished Brass finish
- PC Polished Chrome finish

Overview	① Brass Numeral illustrated	② General dimensions of Brass Numeral	③ 1x 17mm starter screw	④ 2x 19mm Brass screw
----------	-----------------------------	---------------------------------------	-------------------------	-----------------------

 M Marcus Ltd., Dudley

Product Code	Material	Sizes shown are in mm and approximate. We reserve the right to amend where necessary and without any prior notice.
C1560 8	Solid Brass	